

| | | |
|-----------|-----------|---|
| DATE: | Contact: | Mr MARBLE™ ORDER DESK FAX:905-760-2395 |
| STORE: | TEL: | |
| LOCATION: | FAX: | Pick Up <input type="checkbox"/> |
| PO#: | TAG Name: | FOB Ship Pt. <input type="checkbox"/> |
| | | FOB Dest. <input type="checkbox"/> |

CORNER SOAP HOLDER (WM)

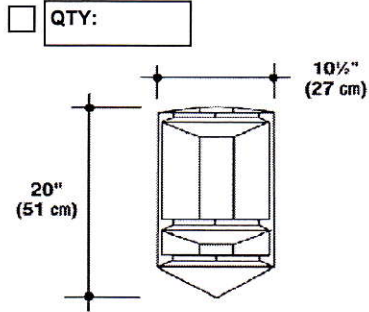

SOAP SHAMPOO HOLDER (RM)

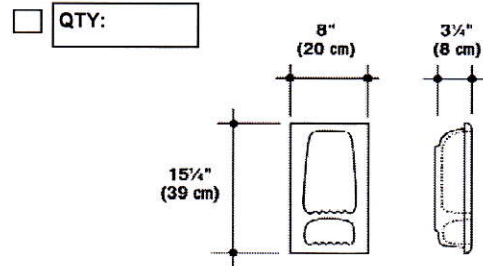

CORNER SHELF (WM)

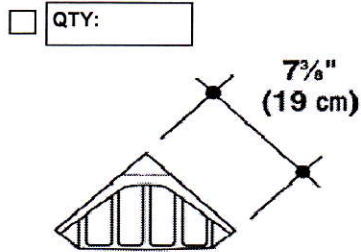

SHAMPOO HOLDER (RM)

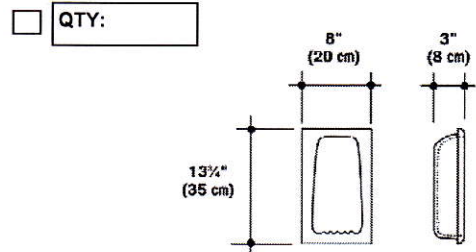

RECESSED SOAP DISH (RM)

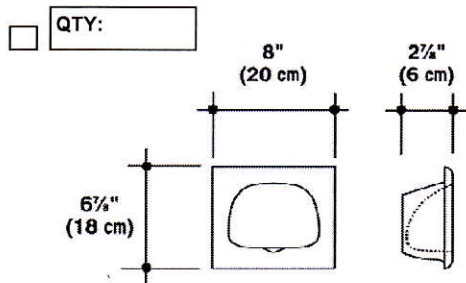

OVAL CORNER SEAT (WM)

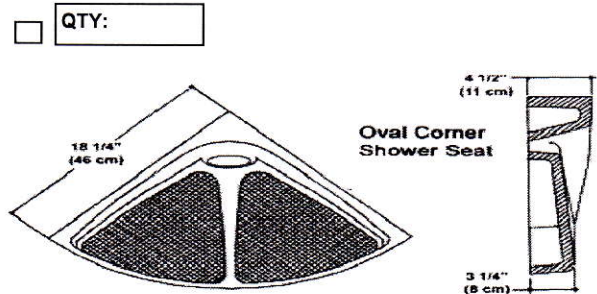

Shower Slab Accessories

CORNER SOAP LEDGE (WM)

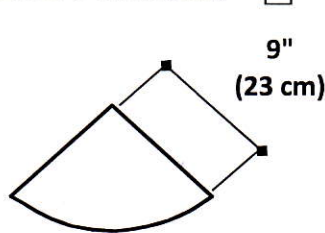

CORNER SEAT

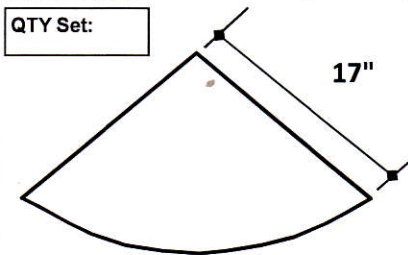

SUPPORTS LEGS (WM)

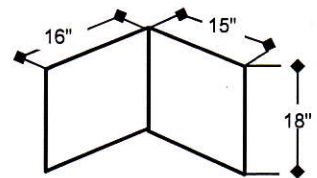

COLOR/FINISH:

WM = Wall Mount

RM = Recess Mount

CODE:

PACKAGING
YES NO

Signature/PRICE: